

2000-3000-4000 Series

Bag palletizers for high capacity range



The series 2000 / 3000 / 4000, particularly dedicated to bag palletizing for building materials, can treat throughputs up to 5000 bags / hour.



newtec bag palletizing



2000-3000-4000 Series : Bag palletizers for

Series 2000

Model 2000 - up to 2000 bags/h
Bag orientation by side pushing system and movable turning post.

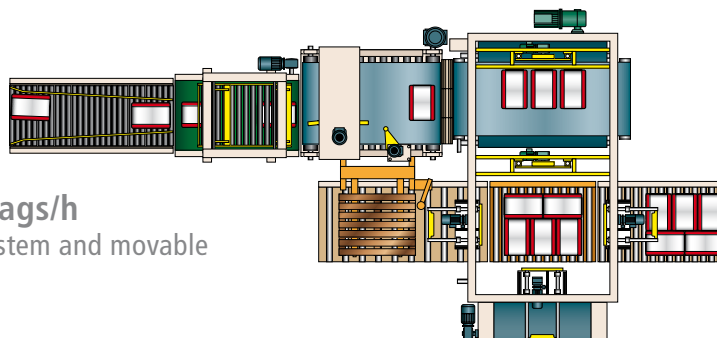

Model 2500 - up to 2500 bags/h
Bag orientation by side pushing system and movable turning post.
Upstream preparation belt.

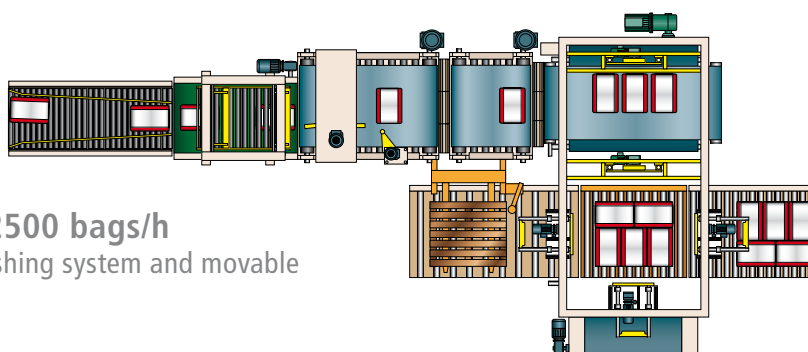

Series 3000

Model 3000 - up to 3000 bags/h
Bag orientation system type "Flip-Flap" with 2 multiposition stoppers, able of any orientation at high speed. Bag transfer with motor driven intermediate drums. Upstream preparation belt.

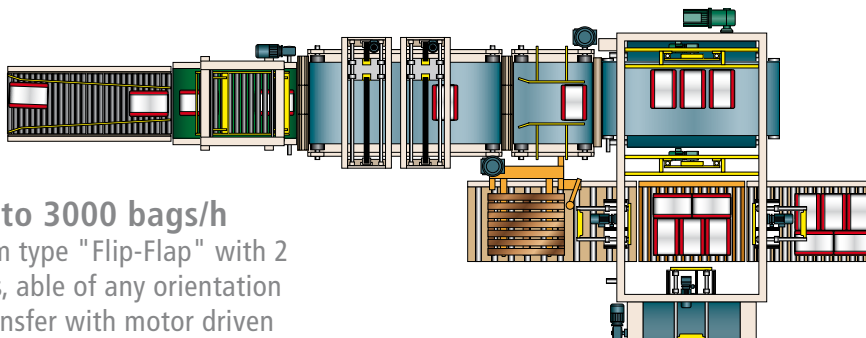

Series 4000

Model 4000 - up to 5000 bags/h
Bag orientation by side pushing system and movable turning post. Bag transfer with motor driven intermediate drums. Upstream pre-grouping belt.

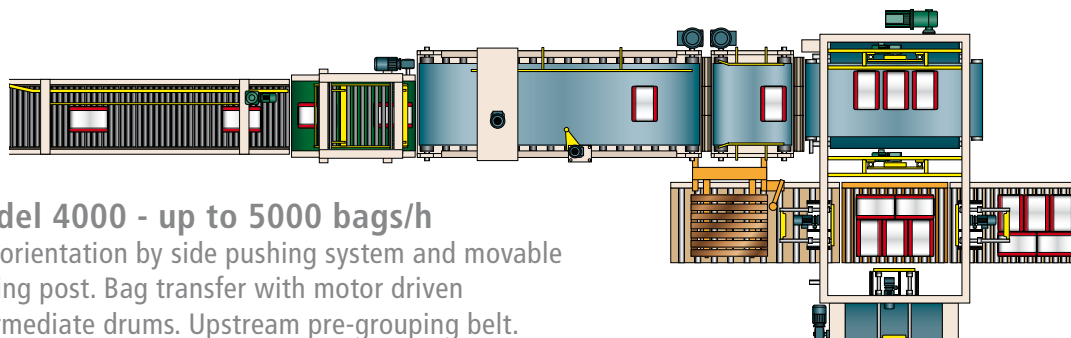

high capacity range

- 1 - According to a proven process, rows then layers are formed step by step without contact between bags. So this "electronic spacer" preserves the bags integrity and their shape.
- 2 - Bags turned with movable turning post. This robust and easy system is particularly suitable for aggressive products in valved bags
- 3 - A complementary options range completes the newtec range. Here, film unreeling on the empty pallet.
- 4 - The system can be completed with a pallet press if the product requires it.
- 5 - An easy movement sequencing guarantees an optimal availability of the machine.

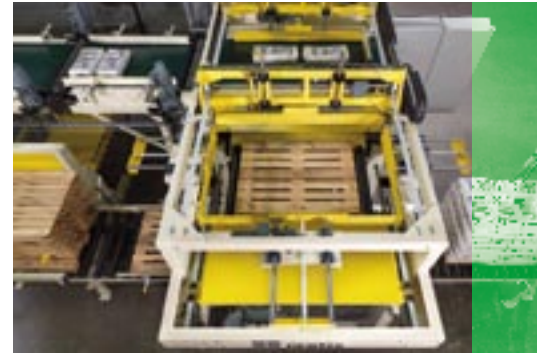

1



2

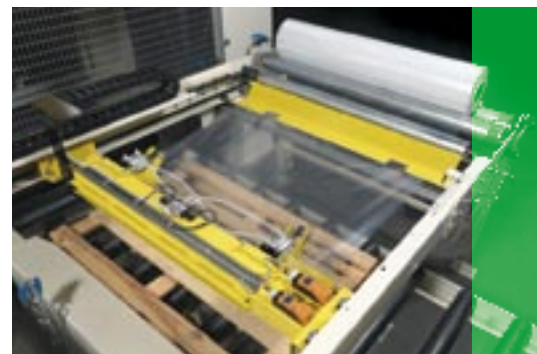

3



5



4



newtec bag palletizing is also:

- A complete range of palletizing machines with robotized gripping tool up to 1200 bags/hour.
- A complete range of stretch hooders for a work rate of up to 120 pallets/hour.
- An automatic bagging machine offer for valve, open mouth and FFS bags.



07/2008

 **newtec bag palletizing**